



# PRODUCT OVERVIEW





# WORLDWIDE OPERATIONS



## ABOUT THE COMPANY

SMST, situated in Drachten (the Netherlands), is an internationally-oriented company that designs and builds offshore equipment. The SMST products cover a wide range of systems for access, lifting, drilling, pipelaying and specials.

Through the unique combination of our in-house design and engineering expertise, production facilities, testing capacity, worldwide installation and service, SMST is able to deliver complete, turnkey systems that are built to customer's specifications.

All our products are designed and built in accordance with the international standards and are certified by recognized authorities such as DNV, LRS, BV and ABS. As for all our products, our focus is to deliver systems with superior functionality and quality.

To meet the specific needs of our clients, our product range is constantly evolving. SMST constantly challenges technical possibilities, with approximately 150 employees who are given the opportunity to grow with the developments of the company.

SMST delivers complete, turnkey systems and innovative solutions by handling all projects in-house:

- CONCEPT & PRODUCT DEVELOPMENT**
- DESIGN & ENGINEERING**
- MANUFACTURING & PRODUCTION**
- COMMISSIONING, SERVICE & AFTERSALES**

## INNOVATIVE SOLUTIONS

We are constantly working on new solutions and systems which we believe add value to the market's existing technologies. These innovations are implemented into many of our products.

As we have extensive operational experience with a wide variety of heavy construction equipment, we are able to use the best solutions for new products and projects. Our internal disciplines include Mechanical, Structural, Naval, Hydraulic, Electrical and Software Engineering.

## RENTAL

### Rentals for short and long term projects

SMST provides a broad range of offshore equipment rentals within the offshore industry. Not only are our offerings comprehensive, our systems also rank among the best in the industry in terms of quality and performance.

The equipment is developed in such a way that it can be operated by your own crew. For the complete rental fleet, SMST also provides a training program for all our equipment. The right knowledge and the right skills are required to operate in a safe, controlled and certified manner.

When you need a solid temporary solution, SMST has the equipment you want to get the job done.

**More information: [www.smst.nl](http://www.smst.nl)**

## OUR STRENGTHS

- ✔ In-house development
- ✔ Modular setups for complete product range
- ✔ Active and passive motion compensation systems
- ✔ Cost-effective
- ✔ Ease of mobilization and transportation
- ✔ Worldwide availability
- ✔ Service under SMST coverage worldwide, 24/7 support



# PRODUCT OVERVIEW



OFFSHORE CRANES



OFFSHORE ACCESS



DRILLING EQUIPMENT



PIPELAY EQUIPMENT



SPECIALS

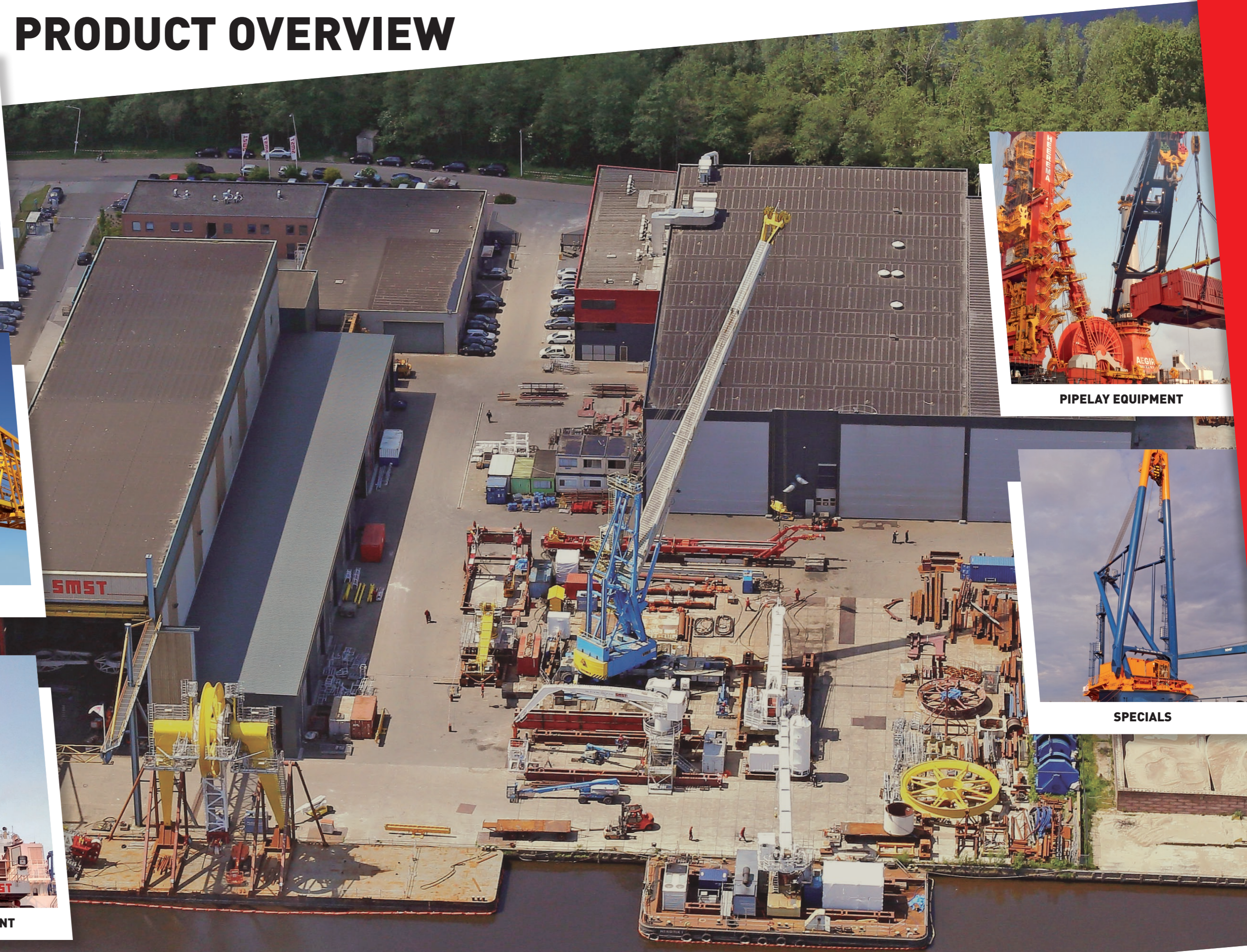



# OFFSHORE CRANES

A SMST offshore crane is designed for a wide range of deck and offshore handlings. Vessels equipped with a crane from the SMST range are capable of handling, lifting and lowering equipment under rough sea conditions. The Active Heave Compensation System installed on the crane compensates the vertical motions of the vessel.

Winches can be delivered in various sizes. From a small winch for deck-handling up to ultra-deep-water winches (up to 3000 meter). The cranes can be outfitted in different configurations: knuckle boom, telescopic boom, fixed boom or 3D knuckle boom.

All our offshore crane solutions are based on technology proven through years of experience and meet the latest offshore rules and regulations.

## FEATURES

- ✔ Compensation of vessel motions by means of Active Heave Compensation
- ✔ Lifting range from 5t up to 150t and up to 3000m hook travel
- ✔ Controls via Remote Control Unit or from control cabin
- ✔ Modular-based crane design
- ✔ Certified for personnel lifting
- ✔ AOPS & MOPS
- ✔ Auxiliary winch
- ✔ Remote Monitoring System



SIZE S



SIZE M



SIZE L



SIZE XL



## STANDARD RANGE

SERIE	SIZE S		SIZE M				SIZE L					SIZE XL				
PEDESTAL DIAMETER	1300mm		1800/2200mm				2600mm					3200mm				
MAX. OUTREACH	20m		25m				35m					45m				
MAX. SWL	25t		50t				100t					150t				
MAX. WATERDEPTH	4000m		4000m				4000m					4000m				
SWL	300	1000	300	1000	1500	2000	300	1000	1500	2000	3000	300	1000	1500	2000	3000
5t	K-S-1F-5-300	K-S-1F-5-1000	K-M-1F-5-300	K-M-1F-5-1000	K-M-1F-5-1500	K-M-1F-5-2000	K-L-1F-5-300	K-L-1F-5-1000	K-L-1F-5-1500	K-L-1F-5-2000	K-L-1F-5-3000	K-XL-1F-5-300	K-XL-1F-5-1000	K-XL-1F-5-1500	K-XL-1F-5-2000	K-XL-1F-5-3000
15t	K-S-1F-15-300	K-S-1F-15-1000	K-M-1F-15-300	K-M-1F-15-1000	K-M-1F-15-1500	K-M-1F-15-2000	K-L-1F-15-300	K-L-1F-15-1000	K-L-1F-15-1500	K-L-1F-15-2000	K-L-1F-15-3000	K-XL-1F-15-300	K-XL-1F-15-1000	K-XL-1F-15-1500	K-XL-1F-15-2000	K-XL-1F-15-3000
25t			K-M-1F-25-300	K-M-1F-25-1000	K-M-1F-25-1500	K-M-1F-25-2000	K-L-1F-25-300	K-L-1F-25-1000	K-L-1F-25-1500	K-L-1F-25-2000	K-L-1F-25-3000	K-XL-1F-25-300	K-XL-1F-25-1000	K-XL-1F-25-1500	K-XL-1F-25-2000	K-XL-1F-25-3000
50t							K-L-1F-50-300	K-L-1F-50-1000	K-L-1F-50-1500	K-L-1F-50-2000	K-L-1F-50-3000	K-XL-1F-50-300	K-XL-1F-50-1000	K-XL-1F-50-1500	K-XL-1F-50-2000	K-XL-1F-50-3000
75t												K-XL-1F-75-300	K-XL-1F-75-1000	K-XL-1F-75-1500	K-XL-1F-75-2000	K-XL-1F-75-3000
100t												K-XL-1F-100-300	K-XL-1F-100-1000	K-XL-1F-100-1500	K-XL-1F-100-2000	K-XL-1F-100-3000
150t												K-XL-1F-150-300	K-XL-1F-150-1000	K-XL-1F-150-1500	K-XL-1F-150-2000	K-XL-1F-150-3000





# 3D MOTION COMPENSATED CRANES

The SMST Motion Compensated Crane (MCC) is designed to be mounted on Service Operation Vessels and Walk-to-Work Vessels.

In harsh conditions, the Motion Compensated Crane safely transfers equipment to an offshore structure. The vessel motions are compensated in all directions by means of the 3rd compensated knuckle. The main application of the crane is to move tools, small generators, spare parts and containers to offshore wind turbines and substations. As there is only limited space on the platforms, it is important that the crane can position the load on the drop zone, even while the vessel is moving due to waves and current. The 3rd knuckle is interchangeable with a subsea knuckle for deep-water operations.

## FEATURES

- ✓ Large operational window
- ✓ Significant wave height up to Hs 4.5
- ✓ Safe cargo handling
- ✓ Compact knuckle design for operating around wind turbine
- ✓ Active motion compensation
- ✓ Excellent lifting capacity
- ✓ Low power consumption



SERIES	SIZE M	SIZE L	SIZE XL
3D ACTIVE MOTION COMPENSATION	1-3t	3-6t	6-10t

# ACCESS & CARGO TOWER

The Access and Cargo Tower is designed to ensure safe and efficient transfer of personnel and goods to the offshore wind turbines or offshore platforms.

The system is an integrated system for stepless transfer of personnel and cargo from multiple deck levels up to the turbine platform. To ensure comfortable crossing and maximum workability, the height of the access bridge can be adjusted to the landing height of the platform. The integrated elevator has capacity for a cargo pallet and personnel always stops at the access bridge level.

The motion compensation system uses slewing, telescoping and luffing movements to compensate the movements of the tip of the bridge. Compensation can be active as well as passive. Optionally, a windfarm cargo crane or 3D motion compensated crane can be installed at the top of the tower.

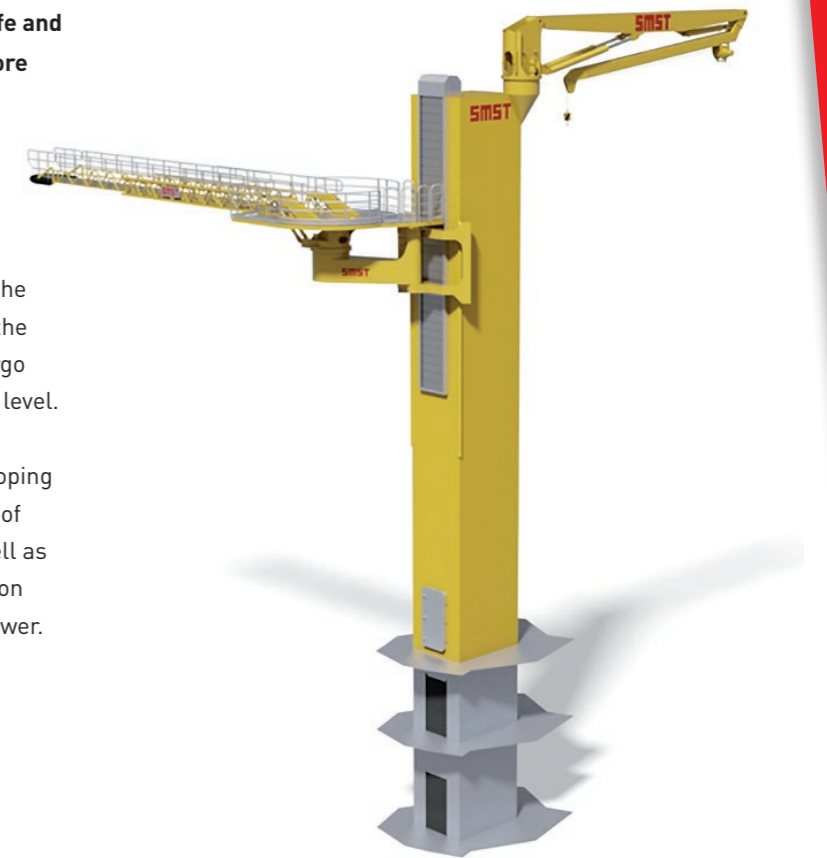

SMST Access & Cargo Tower



Access & Cargo Tower on board of the new ACTA AURIGA

## FEATURES

- ✓ Controls via Remote Control Unit or from vessel bridge
- ✓ Technician & cargo handling from below deck up to the wind turbine via the elevator and gangway
- ✓ Complete solution comprising elevator, motion compensated gangway and crane
- ✓ Suitable for starboard & portside operations
- ✓ Stepless transfer of cargo and personnel to wind turbine
- ✓ Active motion compensation by motion-reference unit
- ✓ Optional cargo top crane
- ✓ Integrated with vessel-dynamic positioning system
- ✓ Remote-controlled SMST trolley which can self-load, transport and unload Euro pallets and cargo boxes





# GANGWAYS

## TELESCOPIC ACCESS BRIDGES (TAB)

SMST provides a wide range of Telescopic Access Bridges (TAB) for safe and easy transfer of personnel to and from an offshore structure. Smart design has resulted in lightweight bridges and low power consumption.

SMST offers a range of Telescopic Access Bridges: S, M, L and XL, varying in length from 4 up to 58m. The bridges can be actively or passively motion compensated and are available for purchase or rent.



Range (standard)	SIZE S	SIZE M	SIZE L	SIZE XL
LENGTH	4-12m	7-30m	19-40.5m	28.5-58m
MOTION CONTROL	Passive/Active Motion Compensation	Passive/Active Motion Compensation	Passive Motion Compensation/Active approach	Passive Motion Compensation
VESSEL TYPE	13.5m and 24m Fast Offshore Craft, Walk-to-Work vessels	Various vessels, incl. Walk-to-Work vessels	Accommodation units, work vessels	Accommodation units, work vessels
APPLICATION	Quick respond Walk-to-Work	General support, offshore windfarms	Crew transfer and utilities supply	Crew transfer and utilities supply

# GANGWAY FEATURES

## IMPROVED VESSEL OPERATIONS

- ✔ High workability, significant wave heights up to Hs 3m, high system speeds, longer telescopic stroke
- ✔ Minimum deck space required
- ✔ Low weight
- ✔ Low energy consumption
- ✔ High level of safety features
- ✔ Easy to operate by own crew



## FULL PROJECT SUPPORT

- ✔ Project-specific workability analysis
- ✔ Vessel-interfacing engineering
- ✔ Remote-access system
- ✔ Operator training on training facility on site
- ✔ Worldwide support



## FLEXIBILITY

- ✔ Rental fleet, for short & long durations
- ✔ Modular setups
- ✔ Fast mobilization
- ✔ Continuous flow of cargo & personnel
- ✔ Attractive financial solutions





# GANGWAY MODULAR SETUP

Since jobs and vessels vary all the time, SMST wants to offer you flexibility. It has developed Telescopic Access Bridges comprising modular components.

SMST's configurator takes us into the modular-based setup, which enables you to set up a TAB that meets all project-specific requirements, while the system is composed of standard components. A step-by-step guide helps in configuring the right TAB. Note that the module choices that are offered are specification and/or cost drivers. Lower-specified components are less costly than the higher-specified kind of component. If you keep this in mind, selecting the components that fit the requirements becomes an easy job.

## FEATURES

- ✓ Containerized footprint
- ✓ Fast mobilization
- ✓ High workability through active motion compensation
- ✓ Operating by own crew
- ✓ Working on height by stacking modules
- ✓ Fully operational in only 1 day
- ✓ Easy to work with by vessel's crew
- ✓ Low cost with attractive day rates
- ✓ Immediately available and applicable worldwide
- ✓ Suitable for small vessels
- ✓ Responsive to market's developments

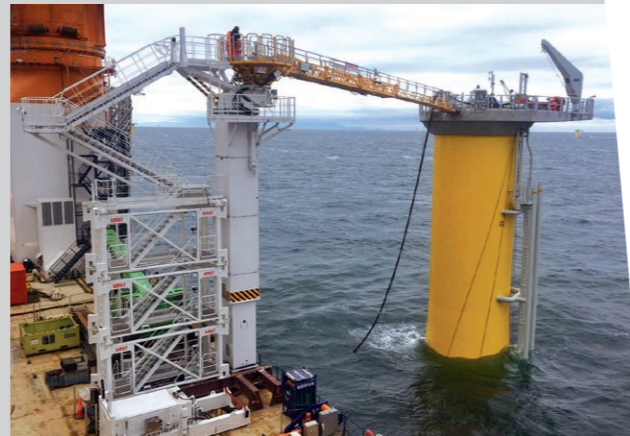

## WORKABILITY

Every vessel has its own motion characteristics which result in compensation movements of the TAB. The system's operational window must be consistent with the area in which operations need to be performed and with the vessel on which it is placed. Therefore, SMST has developed tools that indicate how well the TAB can perform on a vessel in a real operational situation.

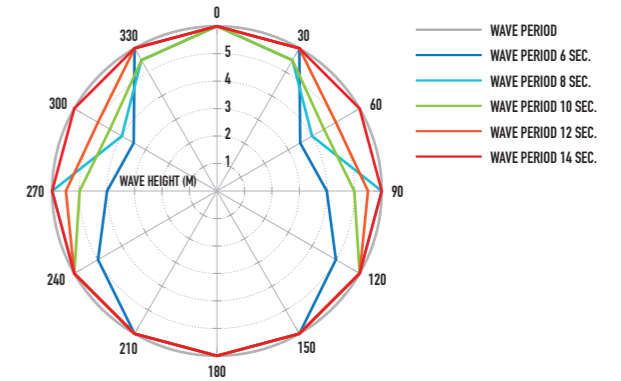

On request, a workability analysis can be performed for every specific vessel and operational situation.

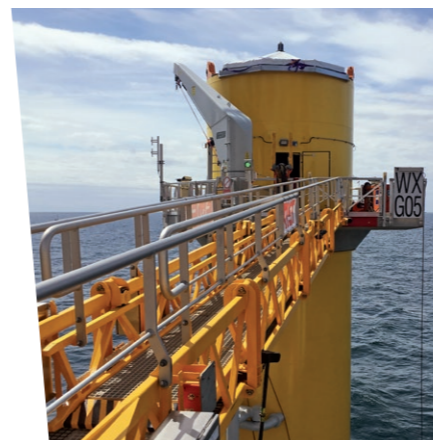

## BUILD-UP EXAMPLE

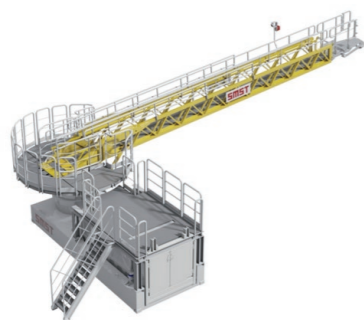

TAB - M Fixed setup



Single Stacking Module



TAB-M & Stacking Modules - with height adjustment

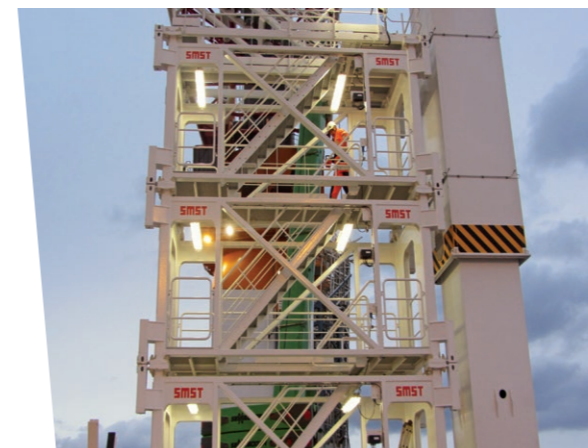



# DRILLING EQUIPMENT

SMST offers a wide variety of drilling equipment and is dedicated to exploring and putting into practice new solutions to improve drilling operations. Our projects are typically complex and innovative, requiring solution-oriented thinking, technical excellence and partnerships with our clients.

SMST has a broad range of drilling systems which are suitable for various handling and drilling operations. Examples of deliveries are shown in the overview below, which gives you an impression of the wide possibilities of our modular drilling systems and pipe-, riser- and BOP handling systems.

## STANDARD RANGE

SIZE S

SIZE M

SIZE L

SIZE XL

### PIPE-HANDLING SYSTEMS

SMST provides a diverse range of pipe-handling systems, including:

- ✔ Pipe-handling cranes
- ✔ Pipe-handling manipulators
- ✔ Catwalk machines
- ✔ Pipe grippers



### MODULAR DRILLING SYSTEMS



**System:** Geotechnical Drilling System  
**Setup:** Semi/portable  
**Hook load:** 60-240t



### BOP HANDLING SYSTEMS

For BOP handling, SMST has developed various systems:

- ✔ BOP cranes
- ✔ BOP c-cart & skidding systems



### RISER-HANDLING SYSTEMS

For riser handling, SMST has designed and built the following systems:

- ✔ Riser-gantry cranes
- ✔ Riser-handling systems
- ✔ Riser transporters

### MODULAR DRILLING SYSTEMS

**System:** Self-Propelled Jack-Up  
**Setup:** Fixed  
**Hookload:** from 500t

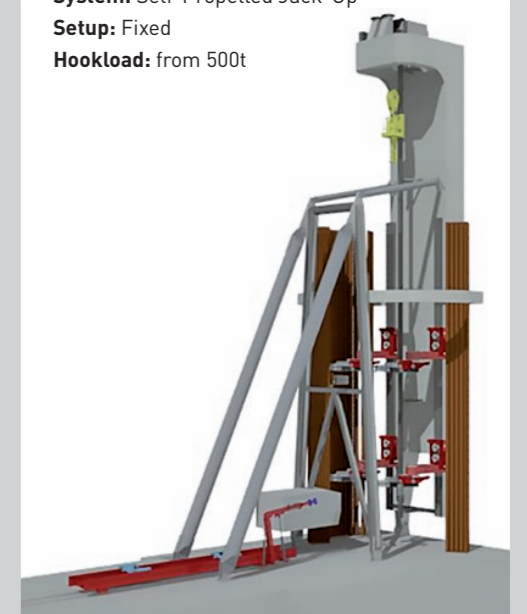



# PIPELAY EQUIPMENT

SMST offers a wide variety of pipelay equipment. Generally, the complexity of our projects and their innovative character require solution-oriented thinking, technical excellence, creativity and a passion for innovation. We can provide both standardized and customized pipelay systems, like PLET handling systems, workstations, spooling systems, etcetera.

An overview of SMST pipelay systems is shown below. This general overview gives an impression of SMST solutions, designed for improvement of a broad range of pipelay operations.

## PRODUCT EXAMPLES

SIZE S

SIZE M

SIZE L

SIZE XL

### PLET HANDLING SYSTEMS

SMST has designed and built PLET handling systems for multiple pipelay vessels, covering a wide range in capacity.



### WORKSTATIONS



SMST has delivered workstations for various pipelay and construction vessels.

### PIPE SPOOLING SYSTEMS



Delivery of land spool base equipment: level winders, reel-drive systems and hydraulic power units.

Delivery of rigid pipe reel spooling system: spooling tensioner system, spooling device and pipe support system.



# SELECTED PROJECTS



AEOLUS

## VAN OORD

We have delivered a Telescopic Access Bridge M Series including flatrack and telescopic pedestal elevator system to Van Oord's installation vessel, Aeolus. The Aeolus is a jack-up vessel and so it has been quite unique that a compensated gangway was necessary.

- ✓ Easy to operate
- ✓ Active motion compensation
- ✓ Stacking modules to enable height compensation of approx. 6m



VOS START

© PIET SINKE WWW.MAASMONDMARITIME.COM

## VROON

The VOS Start is Vroon's first DP2 subsea-support walk-to-work vessel. SMST delivered a 50t subsea knuckle boom subsea crane with active motion compensation.

- ✓ Active heave compensation
- ✓ Performs 3D motion compensated lifts up to 5t with exchangeable motion compensated knuckle
- ✓ Maximizes flexibility



ACTA AURIGA

## ULSTEIN

For the new build of Acta Marine's new construction support vessel (an Ulstein design), SMST has received the order to deliver an Access & Cargo Tower and a 3D motion compensated crane with a lifting capacity of 6t.

The gangway is mounted on an integrated tower including height adjustment and a lift for personnel and cargo. The complete package, with an elevator and access bridge trolley system, allows pallets carrying cargo.

- ✓ Maximizes utilization
- ✓ Increases operational windows
- ✓ Safe and efficient transfer of cargo and personnel

# SERVICE & AFTERSALES

## MAINTENANCE

**Projects don't stop after they have been delivered.**

Systems will require the right maintenance to keep them in reliable working order. SMST understands this and, therefore, provides equipment with the right maintenance schedules to prevent unexpected breakdowns. Besides that, SMST can provide service all over the world to perform regular maintenance to keep the equipment in excellent shape and avoid downtime.

## SPARE PARTS

**The availability of high-quality original spare parts is vital for long-term safe and proper functioning of the equipment.**

We can provide you with all the spare parts you need. Based on our experience, we can assist you in making the right choices in selecting spare part packages throughout the lifetime of the equipment.

## UPGRADES

**The jobs that a vessel and its equipment need to do can change over the years.**

Therefore, SMST offers a range of services to upgrade your equipment customised to your requirements. Our modular approach gives us the opportunity to upgrade existing products to higher specified equipment which is perfect for your new job.

## SERVICE AGREEMENTS

**SMST can also take over responsibility for service, maintenance, spare parts and training by establishing a service level agreement.**

While such an agreement relieves the owner of the responsibility for maintenance, it ensures the availability of vital spare parts in the facility in Drachten. SMST stands for the quality of its products and can extend the guarantee period accordingly.

# TRAINING

SMST can provide a training program for all its equipment, both relating to its rental fleet of products and the systems it sells. We always want to provide you with the right knowledge and skills as to how to operate the equipment in a safe and controlled manner.

- ✓ SMST Technology Training
- ✓ General Gangway Operator Awareness Training
- ✓ Simulator Training
- ✓ E-learning





## SMST DESIGNERS & CONSTRUCTORS BV

De Steven 51-53  
9206 AX Drachten  
PO Box 575  
9200 AN Drachten  
The Netherlands

Phone: +31 512 59 10 00  
Fax: +31 512 59 10 50  
sales@smst.nl  
www.smst.nl

# SMST